

Portable Storage

■ Rent, Lease or Purchase



mobilemodularcontainers.com | 866.459.7600



Portable Storage Containers



10'

Common usage

Container – excess material and equipment storage where space is limited
High Security – landscaping tools, janitorial equipment

Exterior dimensions

length	width	height
10'	8'	8'6"

Interior dimensions

length	width	height
9'4"	7'8"	7'10"

Floor plan

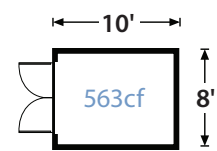

All dimensions are nominal.



20'

Common usage

Container – excess material and equipment storage
High Security – high value inventory
Double Door – allows for access to items on a regular basis; ideal for walkway tunnels, hotel stock and seasonal décor

Exterior dimensions

length	width	height
20'	8'	8'6"

Interior dimensions

length	width	height
19'4"	7'8"	7'10"

Floor plan

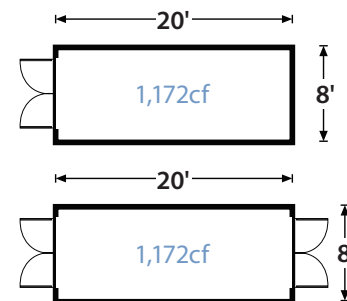

Double-door version also available.



24'

Common usage

Container – ideal for storing piping and other similar materials
High Security – ideal for storing piping in areas with limited security

Exterior dimensions

length	width	height
24'	8'	8'6"

Interior dimensions

length	width	height
23'5"	7'8"	7'10"

Floor plan

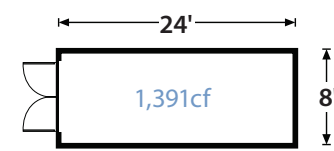

40'

Common usage

Container – multi-use, ideal for larger project sites
High Security – ideal for storage of excess inventory, equipment, and machinery in areas with limited security
Double Door – allows for the quick loading and unloading of various materials; ideal for storage of steel and iron
High Security Double Door – allows for the quick loading and unloading of various materials in areas with limited security

Exterior dimensions

length	width	height
40'	8'	8'6"

Interior dimensions

length	width	height
39'6"	7'8"	7'10"

Floor plan

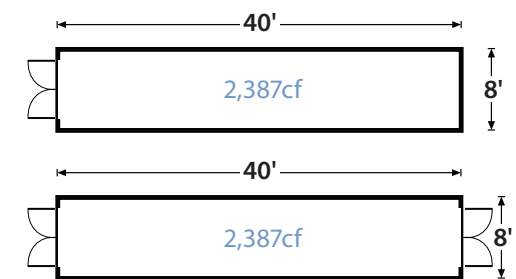

Double-door version also available.

Features

- Lockable door handles
- Uniformly painted fleet in beige to blend in with surroundings
- Available high-security lock option on all units
- Forklift pockets to facilitate movement and stacking
- Optional upgrade to climate-controlled insulated containers



Why Choose Us?

The best drivers – Safety is always our top priority, so all our industry-best equipment is maintained and delivered by our team of highly skilled drivers.

Fast, reliable service – Container delivery and pickup on your scheduled day – without exceptions!

Selection – Choose from a vast selection of high quality, state-of-the-industry equipment, scrupulously maintained with your safety in mind.

Value – Get quotes in ONE business day. Our dedicated Sales Specialists will partner with you to offer competitive prices, so you stay on budget and on time – every time.

Options – We work with you from start to finish to find the right storage option and accessories to suit the requirements and complexities of your project.

High-Security Portable Offices



10'

Common usage
Guard shacks, office space, medical stations, ticket booths

Exterior dimensions

length	width	height
10'	8'	8'6"

Interior dimensions

length	width	height
8'6"	7'4"	7'6"

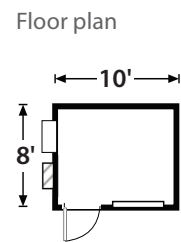

All dimensions are nominal.



20'

Common usage
Office space, conference rooms, breakrooms, temporary retail space

Exterior dimensions

length	width	height
20'	8'	8'6"

Interior dimensions

length	width	height
18'6"	7'4"	7'6"

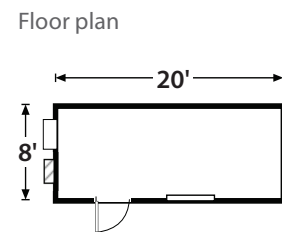

40'

Common usage
Office space, temporary retail space, cooling stations

Exterior dimensions

length	width	height
40'	8'	8'6"

Interior dimensions

length	width	height
38'4"	7'4"	7'6"

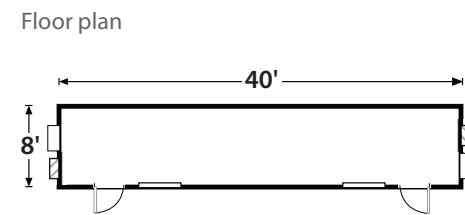

Features

- R-11 insulated walls and ceiling
- Entrance light
- Units supplied with air conditioning and heating
- Security bar(s) on window(s) and door(s)
- Durable flooring
- External GFCI receptacle(s)
- 125 AMP panel box
- Forklift pockets to facilitate movement
- Phone and data access



“ Rented a unit 8 months ago and have not had any issues. We called customer service twice with some questions and they were kind enough to send out a representative who answered all of our questions onsite! Best customer service ever! ”

– Rocky (Construction Industry)

Six

Portable Storage Superpowers Our Customers Love

On-Time Delivery

Our Customer Superheroes are always on time, whether it's for deliveries, installations or pickups.

Reasonable Costs

We work with our customers to arrive at the perfect pricing, and unlike the usual 28-day billing cycle, we use a 30-day cycle.

Solutions for Everyone

Storage, office and combo containers with multiple sizes and accessories to solve your unique problem.

A Passion to Help

Customer Superheroes go beyond “service” – they help solve problems for your business.

Immense Experience

Drivers and reps who really know their job. Gravel, rain, inclines or tight corners cause no delays or extra costs.

Learning with Customers

Your business, goals and opinions all offer valuable lessons for our Customer Superheroes.



High-Security Portable Office & Storage Combos



mobile modular **Plus** Containers



Features

- R-11 insulated walls and ceiling
- Entrance light
- Units supplied with air conditioning and heating
- Security bar(s) on window(s) and door(s)
- Lockable door handles
- Durable flooring
- External GFCI receptacle(s)
- 125 amp panel box
- Forklift pockets to facilitate movement
- Phone and data access

20'

Common usage

Parts storage & distribution, temporary retail space

Exterior dimensions

length	width	height
20'	8'	8'6"

Office interior dimensions

length	width	height
10'5.5"	7'4"	7'6"

Storage interior dimensions

length	width	height
8'6"	7'8"	7'9"

Floor plan

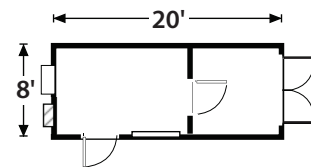

*Storage and office length vary in size. Varies from 10' to 12' office and 6' to 8'6" storage.

Legend

□ Panel Box ◻ HVAC

All dimensions are nominal.

40'

Common usage

Office space, lighted storage space, temporary retail space

Exterior dimensions

length	width	height
40'	8'	8'6"

Office interior dimensions

length	width	height
14'9"	7'4"	7'6"

Storage interior dimensions

length	width	height
23'7"	7'8"	7'9"

Floor plan

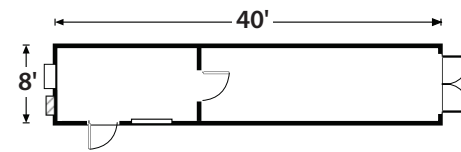

Refrigeration units (reefers) available in select locations

A robust selection of accessories to help you get down to business easier and faster when you order a portable storage, office, or combo container.

Folding Tables & Chairs

Get business done. Our sturdy folding table and chairs will complement your interior space and eliminate the hassle of ordering office furniture from other suppliers. Available for all units.

Note: that table and chair style will vary by region.

High-Security HASP Lock

Designed for an extra measure of security

- Made of steel for maximum strength and durability
- Compatible with a hidden shackle puck lock
- Available on all units



High-Security Puck Lock

Protect your assets

- Keyed-alike sets available when you need multiple locks at a single site and don't want the hassle of numerous keys
- Available for storage and combo units

Pipe Racks

Store a variety of sizes of pipes

- Available with four (4) solid steel support arms
- Ideal for construction applications, allowing you to maximize material storage efficiency
- Facilitates maximum utilization of your portable storage container
- Available for storage units; ask about combo solutions

Shelving Brackets

Organize your items neatly

- Available with three (3) 1,100 lb-rated support arms
- Ideal space-saving and organizing solutions
- Available for storage units; ask about combo solutions

Note: only the shelving brackets included, shelf material supplied by the customer



Plan Tables

Get a sturdy yet economical solution for blueprint review

- Ideal for construction superintendents, foremen and architects
- Surface has a plan lip to ensure your plans remain on the table
- Measurements are: 6'8" W x 3'0" D x 3'1" H
- Available for office and combo units

Damage Waiver

Cover damage to your leased equipment from:

- Fire and smoke damage
- Lightening
- Windstorms/Tornadoes
- Floods
- Hail
- Earthquakes
- Explosions
- Collision with a vehicle

Ask your representative for more information about our Damage Waiver or additional upgrade options specific to your location!

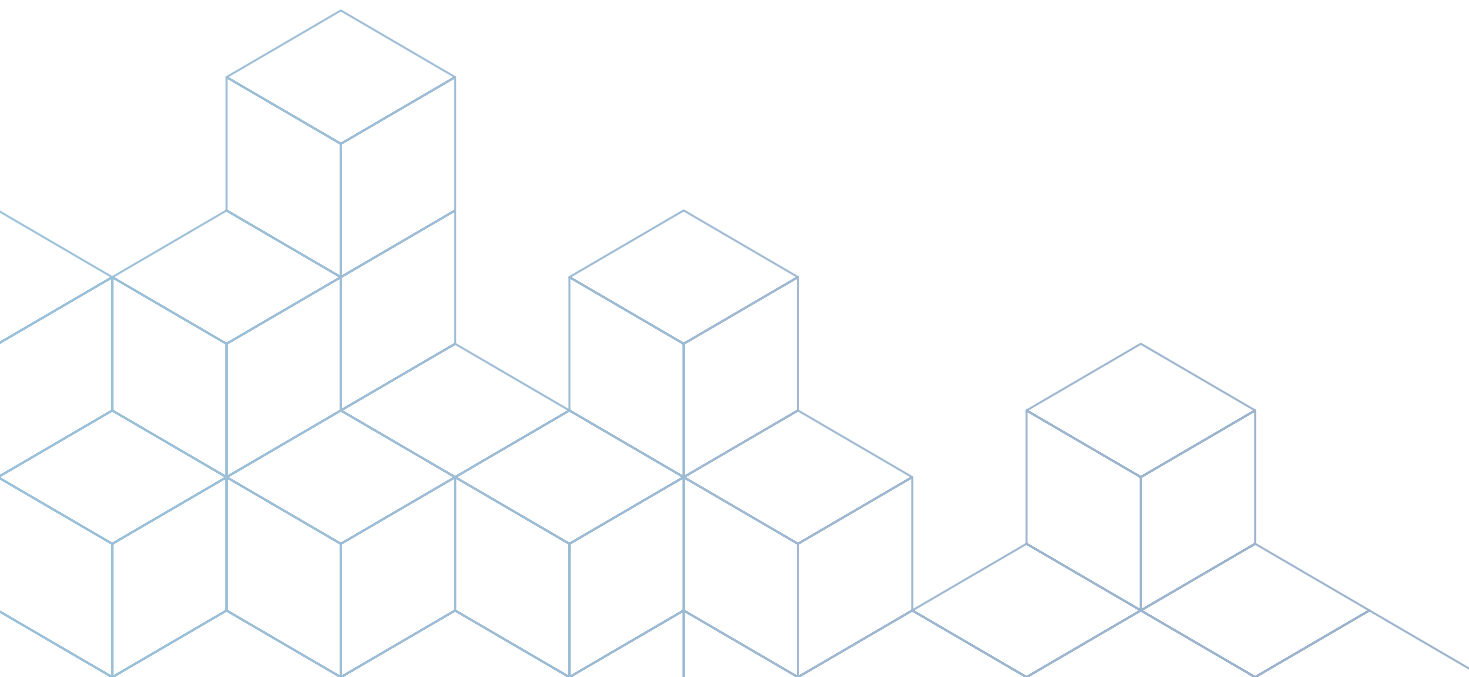



Our Commitment to You:

- We offer competitive prices and options.
- We will deliver your portable storage unit when you need it.
- Get quotes immediately. Our dedicated Sales Specialists will partner with you to offer competitive prices, so you stay on budget and on time – every time.
- We maintain and service our equipment with our own full-time employees which means you will receive a quality portable storage unit every time.
- We have predesigned storage containers for specific industry applications.
- We offer a variety of accessories and upgrades.
- The success of your project is as important to us as it is to you.
- Regardless of the size of your project, you will have one project manager from start to finish.
- We pay attention to every last detail.